

# MX-800



## AUDIO MATRIX 8 AUDIO INPUTS / 8 AUDIO OUTPUTS



### DESCRIPTION

The audio matrix **MX-800** allows the connection of up to 8 inputs MIC/LINE, 8 remote control panels MX-888, 2 paging desks MX-801 and one microphone input for emergency (MIC1). All these inputs can be routed to 8 different zones simultaneously.

The routing of up to 8 inputs to 32 zones (using an interconnected system of 4 matrix MX-800), provides solutions for basic installations as well as others with more advanced configuration.

By using the paging desk MX-801, it allows to page zone wise as well as to all zones. The matrix allows the connection of up to 2 paging desks.

The remote control panels MX-888 are connected to the matrix using an FTP shielded cable in order to send the RS-485 communication, audio and 24VDC power supply.

For evacuation applications, the matrix includes 8 relay input contacts to integrate with the fire alarm system. This allows to send an alarm or evacuation message to the room or zone where the emergency is occurring. The matrix includes an input with maximum priority in order to broadcast a pre-recorded message (evacuation) to all zones.

The audio matrix MX-800 allows an easy installation and a simple management thanks to its user interface. Its management, with a focus towards the excellence of the acoustic performance, allows it to be used in multiple applications:

Offices, conference halls, sport centers, malls,  
train stations, hotels, and airports; among others. ....

### TECHNICAL FEATURES

**Frequency response:** LINE 20Hz - 20kHz ( $\pm 3$ dB)  
MIC 80Hz - 18kHz ( $\pm 3$ dB)

**Audio outputs 1 - 2 - 3 - 4 - 5 - 6 - 7 - 8 (Euroblock):**

Balanced: sensitivity = 1.5 V.  
impedance = 600  $\Omega$ .

**Inputs 1 - 2 - 3 - 4 LINE (RCA):**

LINE: sensitivity = 195 mV - 2 V.  
impedance = 47 K  $\Omega$ .

**Inputs 5 - 6 - 7 - 8 MIC/ LINE Configuration (Euroblock):**

MIC: sensitivity = 5 mV.  
impedance = 600  $\Omega$ .  
phantom supply= 48 VDC.

LINE: sensitivity = 350 mV.  
impedance = 10 K  $\Omega$ .

**Microphone 1:** 5mV / 350mV / 600  $\Omega$ .

**Communication protocol:** RS-485

**Communication port:** RJ-45

**Consumption:** 20 W.

**Auxiliary DC power supply:** 24VDC.

**AC power supply:** 115 / 230VAC / 50-60 Hz.

**Weight:** 10.4 Kg.

**Dimensions:** 484 x 400 x 132 mm.



EQUIPOS Y SISTEMAS MEGAFONÍA / INTERCOM • PUBLIC ADDRESS SYSTEMS

UNIÓN DESARROLLOS ELECTRÓNICOS

Tel.: +34 934 772 854 / +34 609 914 787 • ude@udeaudio.com • BARCELONA - SPAIN



www.udeaudio.com

rev.2 | 610.387A | 1 / 12

## MX-800 FRONT PANEL

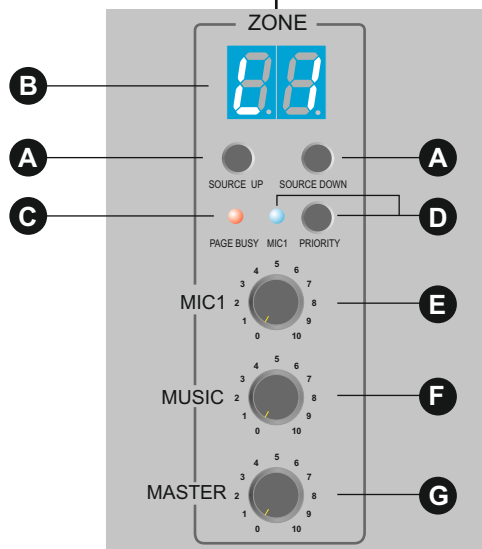
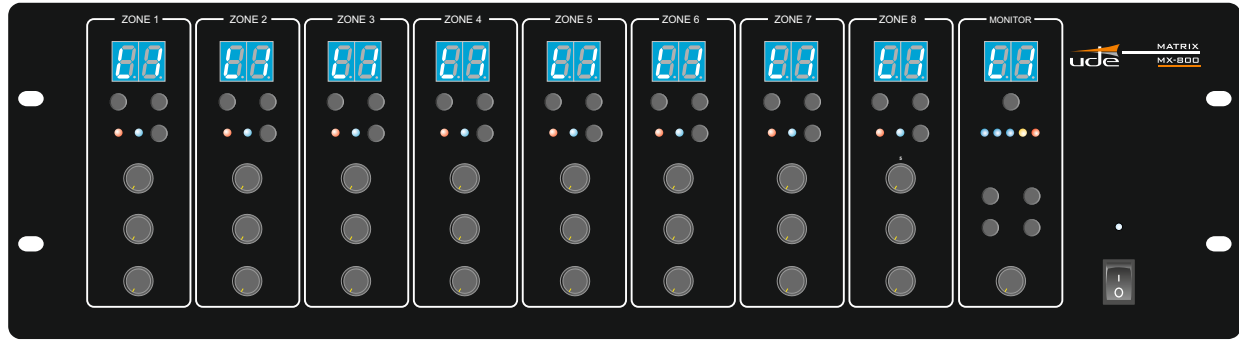

The LED display indications are:

<b>L1</b>	Line Input number 1
<b>L2</b>	Line Input number 2
<b>L3</b>	Line Input number 3
<b>L4</b>	Line Input number 4
<b>L5</b>	Line Input number 5
<b>L6</b>	Line Input number 6
<b>L7</b>	Line Input number 7
<b>L8</b>	Line Input number 8
<b>L</b>	Remote (line or microphone)
<b>OF</b>	No selection

### A. Buttons for source selection.

Buttons “Source Up” and “Source Down” enable the audio source selection for each output. The display shows the selected source number at all times.

Press Source Up or Source Down and once the display shows the desired audio source, press the ENTER button to confirm all system changes. Otherwise the audio source selection will return to its previous selection after 10 seconds.

**Caution!** When the remote control panel (MX-888) is connected, the source selection buttons from the MX-800's front panel will be disabled.

### B. LED display.

A dual digit display shows the audio source selection of each output.

### C. Page busy LED

The orange page busy LED will remain switched on to indicate that the paging desk (MX-801) is broadcasting to that specific zone.

### D. Priority indicator

The MIC1 LED with priority will remain switched on in order to indicate that the MIC1 input has the highest priority against any other input.

### E. MIC 1 control volume

Every paging zone (audio output) has an individual MIC 1 volume control.

### F. Music volume control

The music volume control for each paging zone. If the MX-800 audio matrix has a remote control (MX-888) connected, the music volume control will not work

### G. Master volume control

The master volume control enables the output gain adjustment for each zone of the MX-800 matrix. If the priority of this zone is activated, this control will not be able to adjust the volume neither for the MX-801 paging desk nor the line remote source number 8.

## MX-800 FRONT PANEL

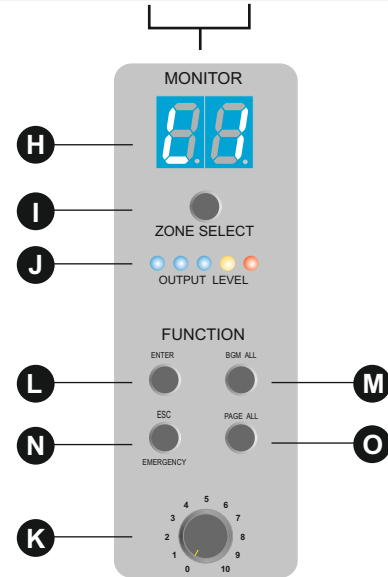
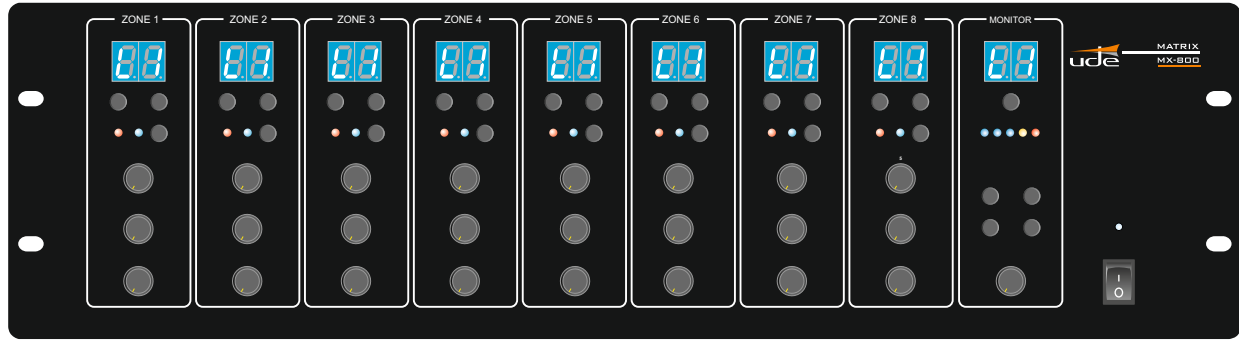

### H. LED display

A dual digit display shows the audio source selection for the monitor.

### I. System monitoring

The MX-800 includes an internal speaker that enables the monitoring of the different matrix's outputs locally. By pressing the "ZONE SELECT" button the user will be able to choose within the 8 possible outputs as well as disable it. Once the output has been selected, the user must press the ENTER button. Otherwise the system will return to its original status.

### J. Monitor VU meter

5 LED meter shows the audio signal level of the selected zone.

### K. Monitor volume

Monitor control audio volume knob.

### L. Enter button

When the systems needs to be confirmed, the "ENTER" button should be pressed.

### M. General broadcasting (BGM ALL)

By selecting this option (BGM ALL), the system will assign a chosen audio input to all outputs automatically. To be able to select the specific input, the user must press the BGM ALL button until the display shows the desired audio input. Then, press "ENTER" to confirm.

### N. ESC button

The "ESC" button cancels all selection and operation not yet confirmed.

### O. General paging (PAGE ALL)

By selecting this option (PAGE ALL), the system will assign the MIC1's highest priority to all outputs automatically. To monitor this selection, the MIC1 LED located on each input will be switched on.

**MX-800 REAR PANEL**

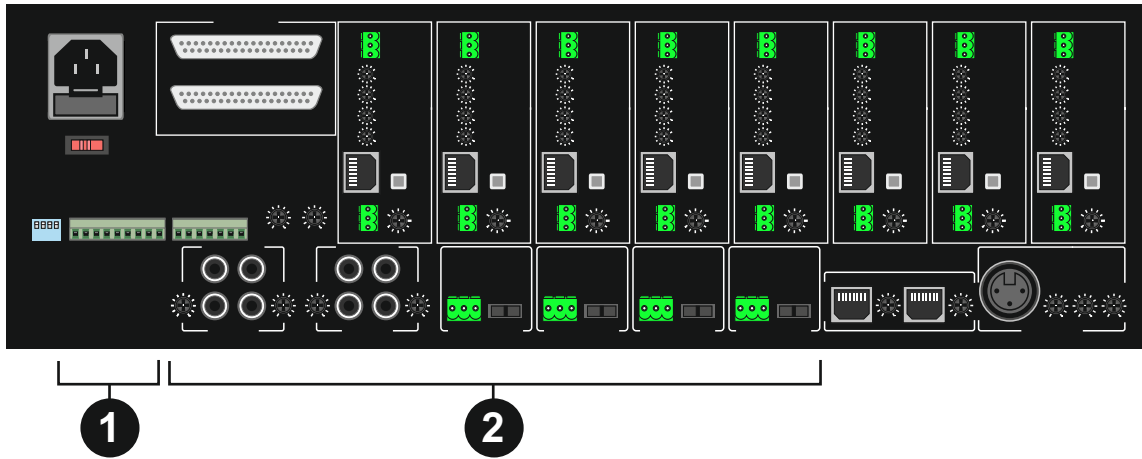

**1. ACOUSTICAL ALARM**

The MX-800 has an internal alarm that can be played in different zones at the same time with a high priority from other audio sources and no attenuation volume will be applied.

When an alarm is played the message "AL" will be showed in the zone LED display, this message can be in one or more paging zones at the same time, in that case the frontal MUSIC and MIC 1 potentiometers will be disabled.

The MX-801 will show a orange LED emergency indicator.

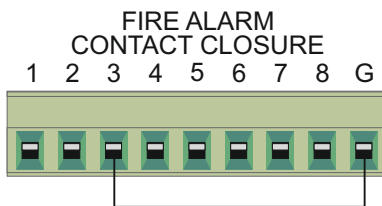

For example, Zone 3 has an emergency:

The desk control MX-801:

The orange LED indicator will turn on.

When the alarm ends all emergency zones change to the configured audio sources, MIC 1 and MUSIC can be configured.

**2. AUDIO INPUTS**

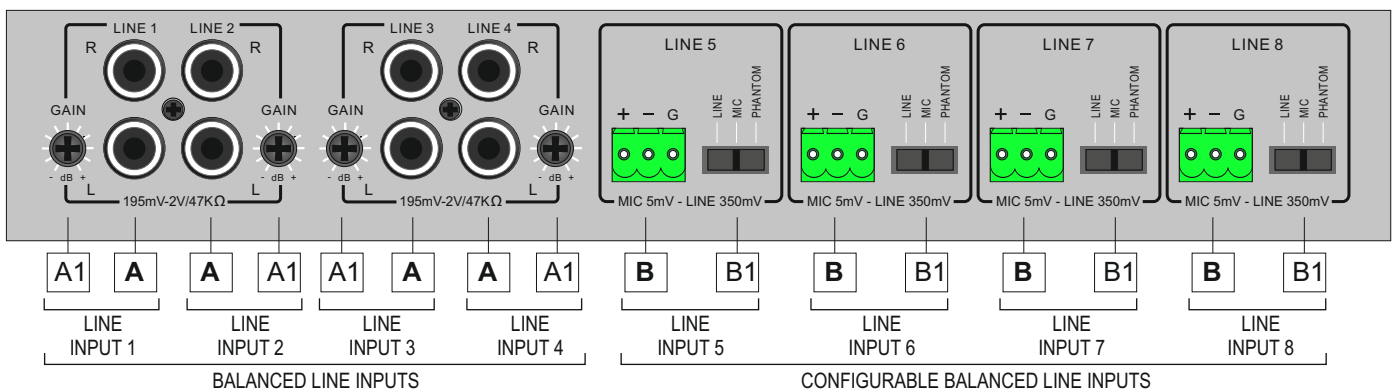

**A RCA Connectors**

The MX-800 audio matrix includes up to 4 line inputs using RCA connectors with an impedance of 47kΩ.

**A1 Line gain**

The line input can be adjusted using the gain control. The 4 inputs ( LINE 1-2-3-4) have an independent gain control by the use of a knob.

**B Euroblock connectors**

The MX-800 audio matrix includes up to 4 balanced line inputs using EUROBLOCK connectors. ( LINE 5-6-7-8)

**B1 Switches for line input configuration**

These switches allow the configuration of each of the 4 inputs to: LINE (10kΩ) – MIC (600 Ω) – MIC with Phantom supply (+48V)

**MX-800 REAR PANEL**

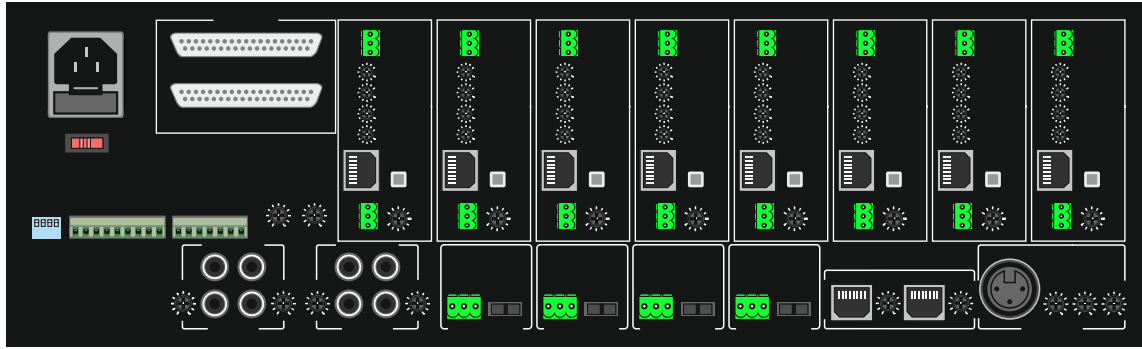

**3**

**3. PAGING DESK**

The MX-800 audio matrix allows the connection of up to 2 paging desks (MX-801) by using the RJ-45 connector.

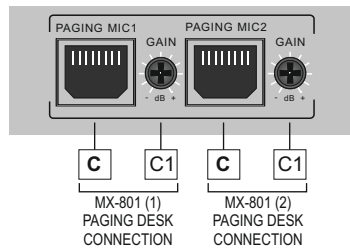

The different paging desks will have the same priority level and the operation mode will be based on the first paging desks which broadcast first. A gain control is provided for each paging desk to adjust the level signal for each one. Besides, the paging desk (MX-801) itself includes its own adjustments on the rear part, as follows:

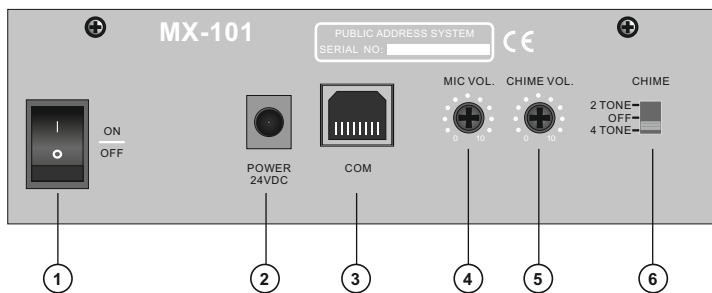

1. Power switch.
2. Supply input.
3. RJ45 port.
4. Microphone volume control.
5. Chime volume control.
6. Chime selector (2 or 4 tones and OFF position)).

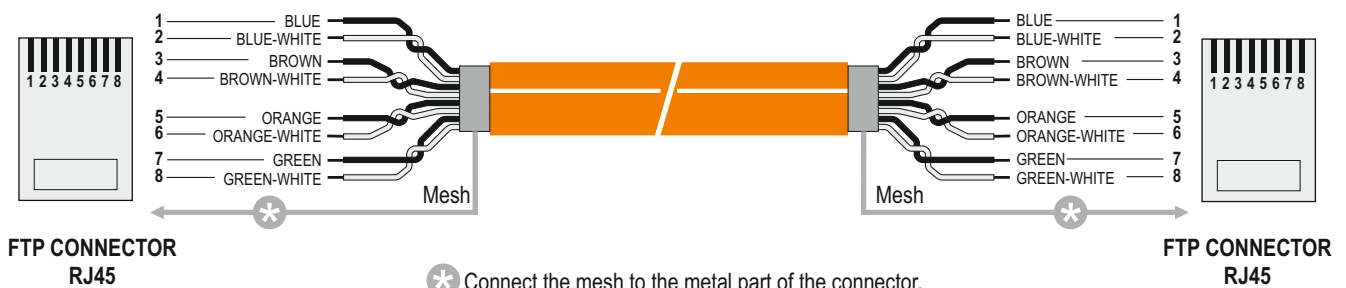

MX-800 REAR PANEL

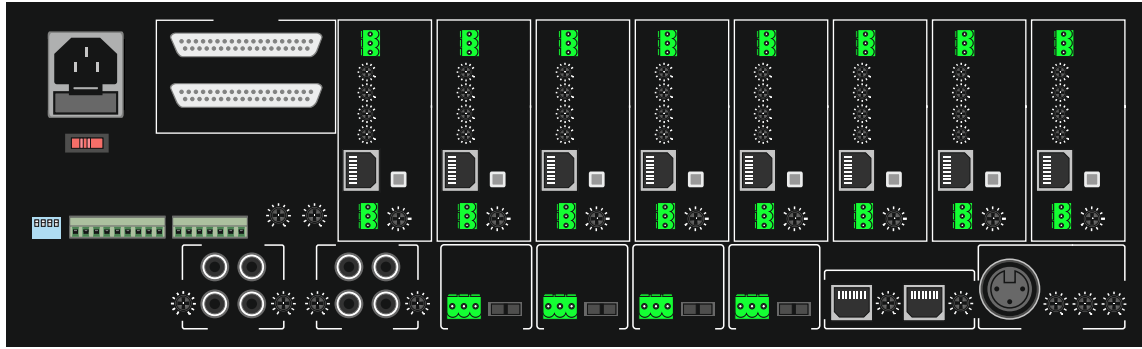

4. MIC 1 INPUT

4.1 MIC1 Connector Input

The MIC1 is a balanced input, with a XLR connector of 600 ohms.

4.2 MIC1 Equalization

The gain for the MIC1 input can be adjusted by using the knob located on the rare part of the MX-800 audio matrix, as well as the low and high pass filters.



4.3. MIC1 Priority

Each of the 8 matrix outputs (MX-800), includes a priority button on the front panel **D** that enables the MIC1 input to have highest priority against any input signals of a specific zone. This selection is independent for each output and once it is enabled, the MIC1 LED will be switched on.

In case the priority button is not activated, the MIC1 signal will be mixed with the rest of the audio inputs of that specific zone.

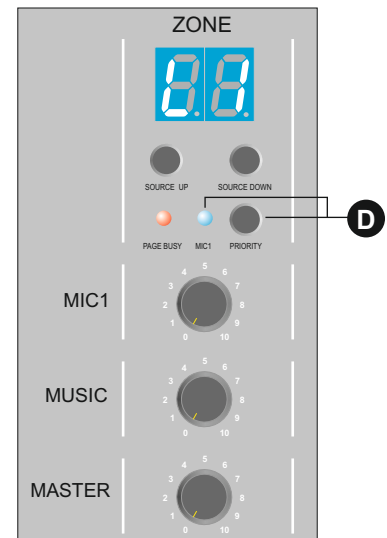

MX-800 REAR PANEL

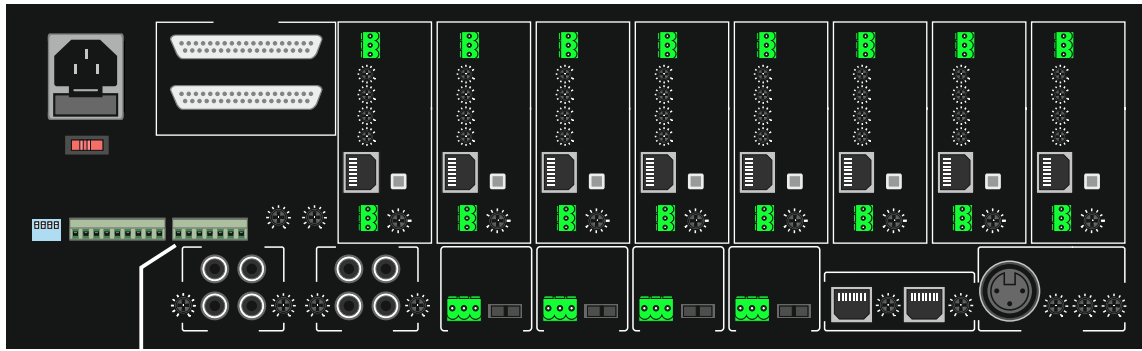

5

**5. Integration with Fire Alarm System (EVAC System)**

The terminal block enables the integration of the matrix with fire alarm systems (EVAC type).

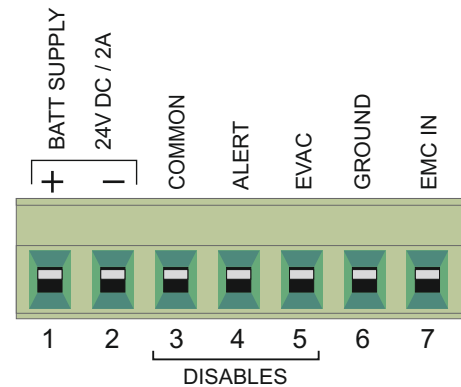

**5.1 Connection to emergency power supply**

- 1. +24VDC (battery backup or UPS).
- 2. Ground

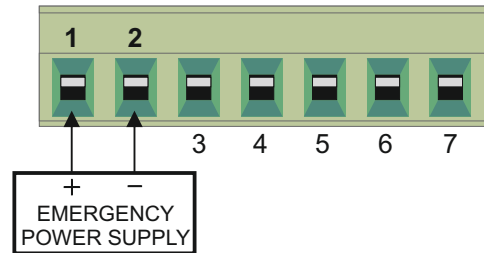

**5.2 Connection to external evacuation message**

- 6. Audio shield
- 7. Audio input (EMC IN)

The evacuation message will be broadcasted to all 8 zones by using signal detection. When the device carrying the evacuation message is activated, the matrix will detect the signal and will broadcast it to all 8 zones.

Next, we show possible solutions with UDE equipment. The first one consists of a GD-36 (pre-recorded message player) connected that can be integrated with the fire alarm system as well. The second option consist of a preamplifier that can actually mix the input of a GD-36 as well as a microphone input and a music source as well. This way, any of these audio sources will have the highest priority in the matrix MX-800.

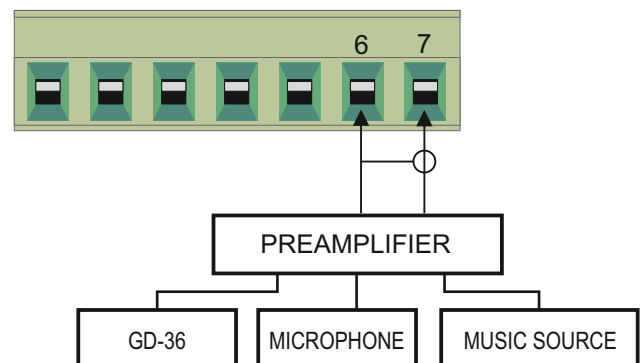
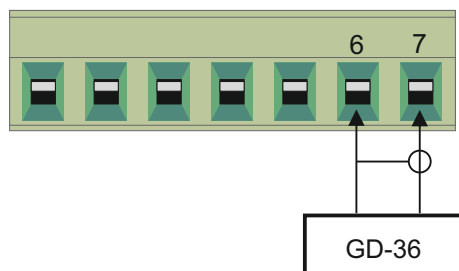

MX-800 REAR PANEL

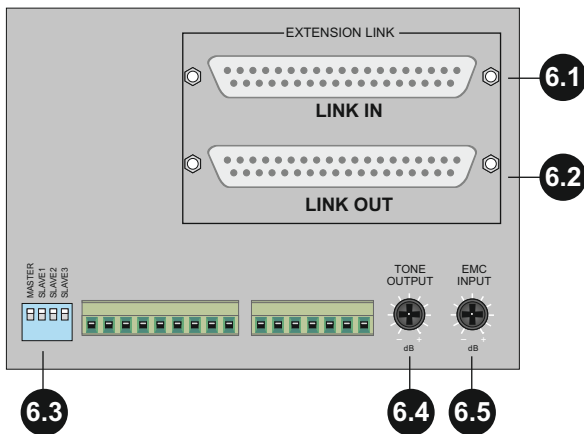
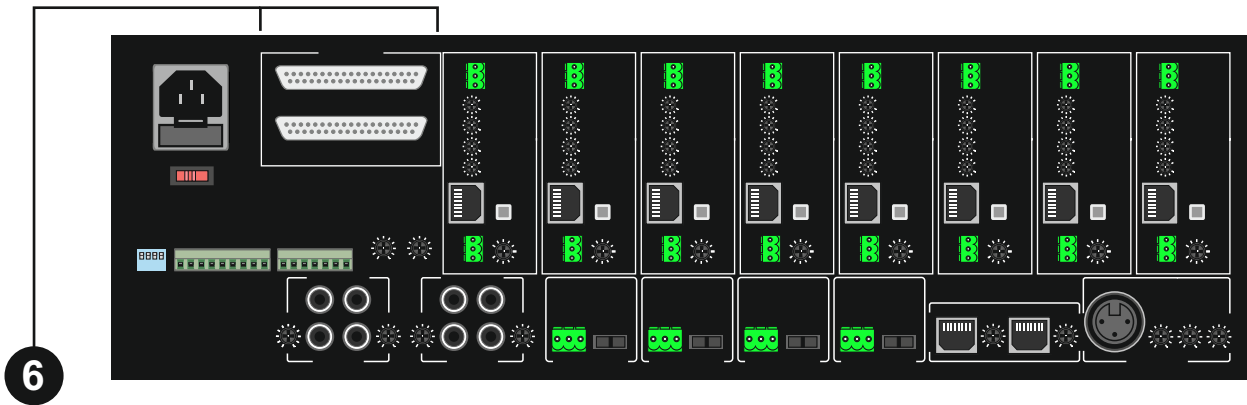

6. MATRIX EXPANSION (SUBD37 CONNECTOR)

The MX-800 matrix system permits the expansion in number of outputs in order to create modular systems based on the matrix interconnection and can provide up to 32 different audio outputs.

The expanded matrix must be linked using a cable with subD37 connectors. This will enable to expand 8 audio inputs, 1 microphone (MIC1) and 2 paging desks to all 32 outputs, including audio and data transmission.

Two link ports are provided for the expansion: one for input (LINK IN – 6.1) and one for output (LINK OUT – 6.2).

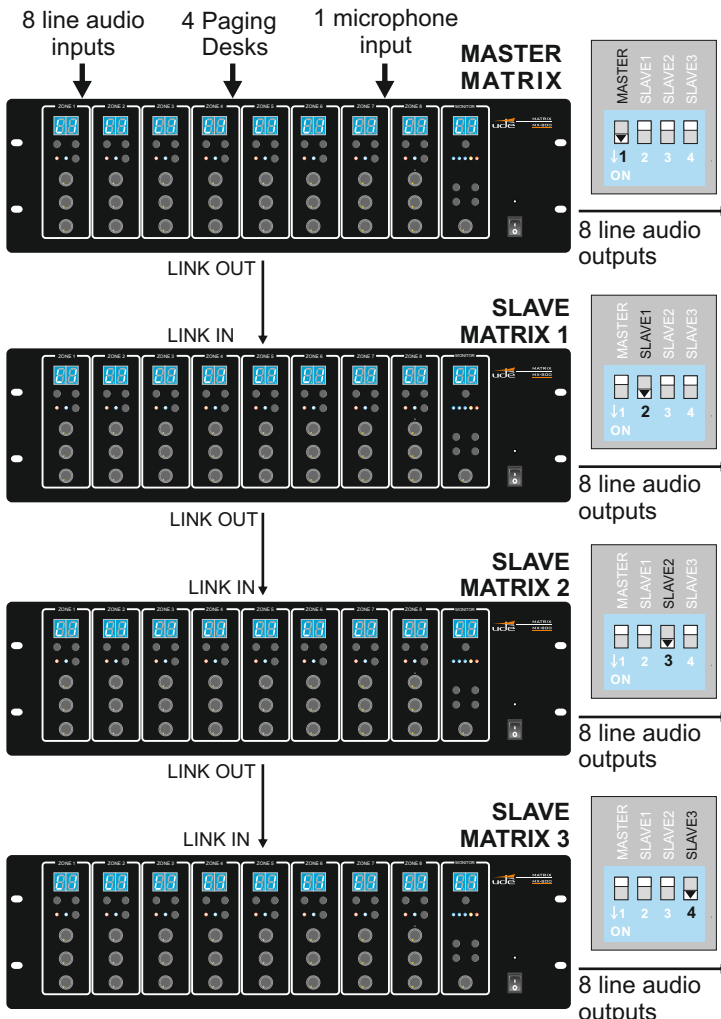

6.3 Master/Slave Matrix configuration.

In order to configure the different matrix within the system, the user should use the DIP switch by selecting any of the following combinations: master, slave 1, slave 2, slave 3.

If the selection of the combinations is configured incorrectly it may lead to the malfunctioning of the system.

**Caution!** When connecting any of the Slave matrix, only the master matrix inputs ( 8 audio inputs, MIC1 and paging desk) will be operative. All the slave matrix inputs will be disabled.

6.4 Emergency siren gain control.

The volume control “TONE OUTPUT” adjusts the emergency siren gain which is triggered by closing a free voltage contact.

6.5 Evacuation message gain control.

The volume control “EMC Input” adjusts the evacuation message gain.



MX-800 REAR PANEL

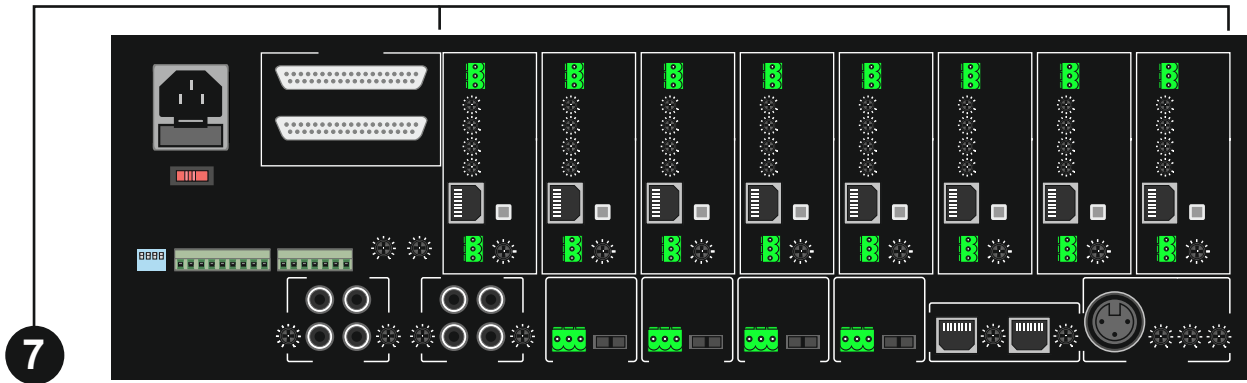

7. AUDIO OUTPUT

7.1 Audio output terminal

Each zone has its individual terminal audio output for audio connection. For example with a Power Amplifier.

7.2 Audio Gain

The zone gain can adjust the audio volume of the zone or audio output. If the line 8 priority is activated, then the audio gain will be disabled.

7.3 Bass and Treble

An audio output bass and treble adjustments are provided in the rear part:

LF: Bass adjustment.

HF: Treble adjustment.

7.4 Paging desk (PAGE)

Volume control for the paging desk (MX-801) signal for the specific zone.

7.5 Remote control panel (MX-888)

The MX-800 matrix enables the possibility of connection up to 8 remote control panels (MX-888). By using the existing RJ45 connector for each matrix input, a remote control panel may be connected to each output by using an FTP or UTP cable.

- 1. RS-485B
- 2. RS485A
- 3. NC
- 4. GND
- 5. +24V
- 6. +24V
- 7. Audio+
- 8. Audio-

7.6 Enable/disable switch

Once the remote control MX-888 is connected to the RJ-45 port, each MX remote control should be enabled with the proper switch.

Caution! Only activate the MX-888 when the remote control is connected.

7.7 Remote source gain

This adjustment is used to control the remote source's gain. This will provide an independent adjustment for each zone.

7.8 Remote source for MX-888

Each zone can have a level remote source assigned to it. It is designed like this in order to enable users who do not want to use the local line input of the remote panels to have the possibility of choosing a remote source for only that zone. Once the MX-888 is linked with the matrix, the remote source can be selected by choosing channel "L".

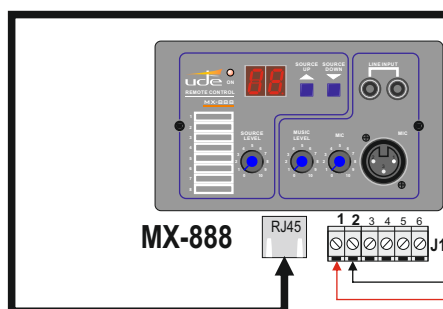
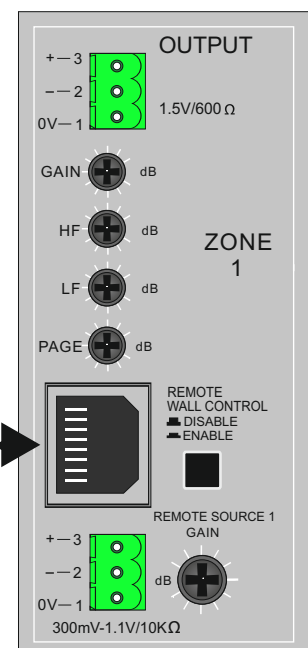
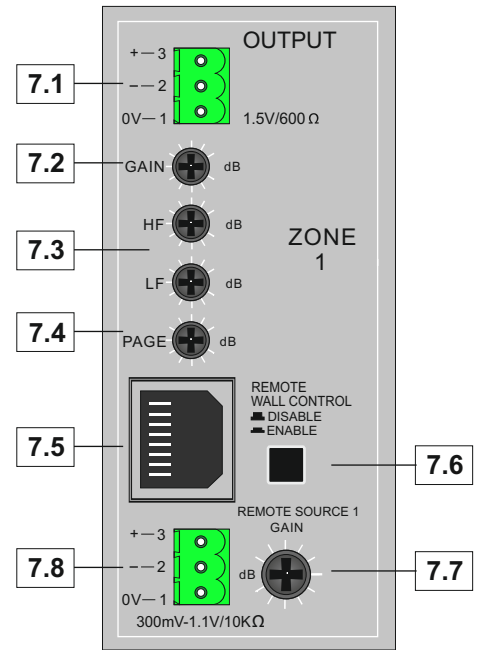

EXTERNAL POWER SUPPLY WZ-5

It is required only if the distance between the remote panel (MX-888) and the matrix (MX-800) is higher than 50 meters.

## SYSTEM CONFIGURATION

Follow the instructions to configure the public address system with the UDE MX-800:

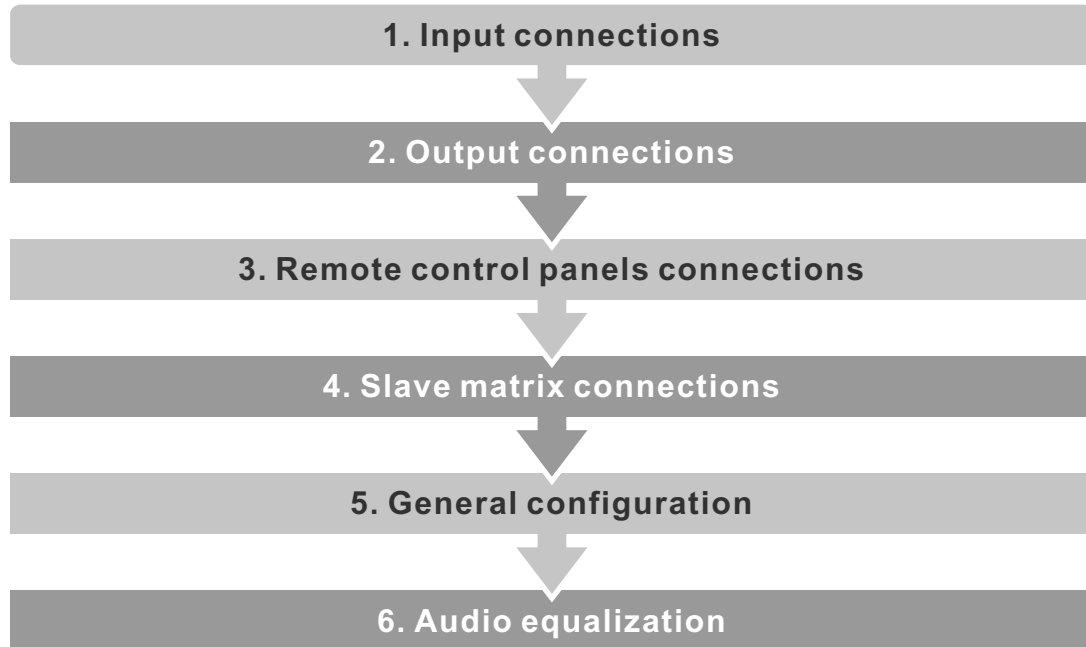

### 1. INPUT CONNECTIONS

The MX-800 allows the connection of up to 8 line audio inputs using RCA connectors. First of all connect the different audio sources to the matrix or in case you have an expanded matrix system, make sure you connect the audio sources to the MASTER matrix only.

Up to 2 paging desks (MX-801) can be connected to the matrix even if we are talking about an expanded matrix system. Connect them using the RJ45 connectors and if the distance between them is higher than 45 meters you must use a power supply for the paging desk.

Finally, the audio matrix includes a microphone input using XLR connector (MIC1) on the rear part of the device. Only one microphone can be used even if there is more than one matrix interconnected. This microphone allows the system to provide a configurable priority input.

### 2. OUTPUT CONNECTIONS

The MX-800 matrix allows the connection of up to 8 outputs. In case of an expanded matrix system the possible outputs increase up to 32. The audio output is connected using a terminal block labeled as "OUTPUT".

### 3. REMOTE CONTROL PANELS CONNECTIONS

The MX-800 matrix allows the connection of up to 8 remote control panels. In case of an expanded matrix system, the system enables the connection to up to 32 remote control panels.

The wiring is performed by using a FTP or UTP cable. Moreover, the remote control must be enabled by activating the REMOTE WALL CONTROL switch at the rear panel of the matrix.

## SYSTEM CONFIGURATION

### 4. EXPANSION MATRIX SYSTEM

By using the ports labeled as EXPANSION LINK, the expansion matrix system can increase the number of outputs up to 32 if required.

In order to do so, the different matrix must be connected as follows:

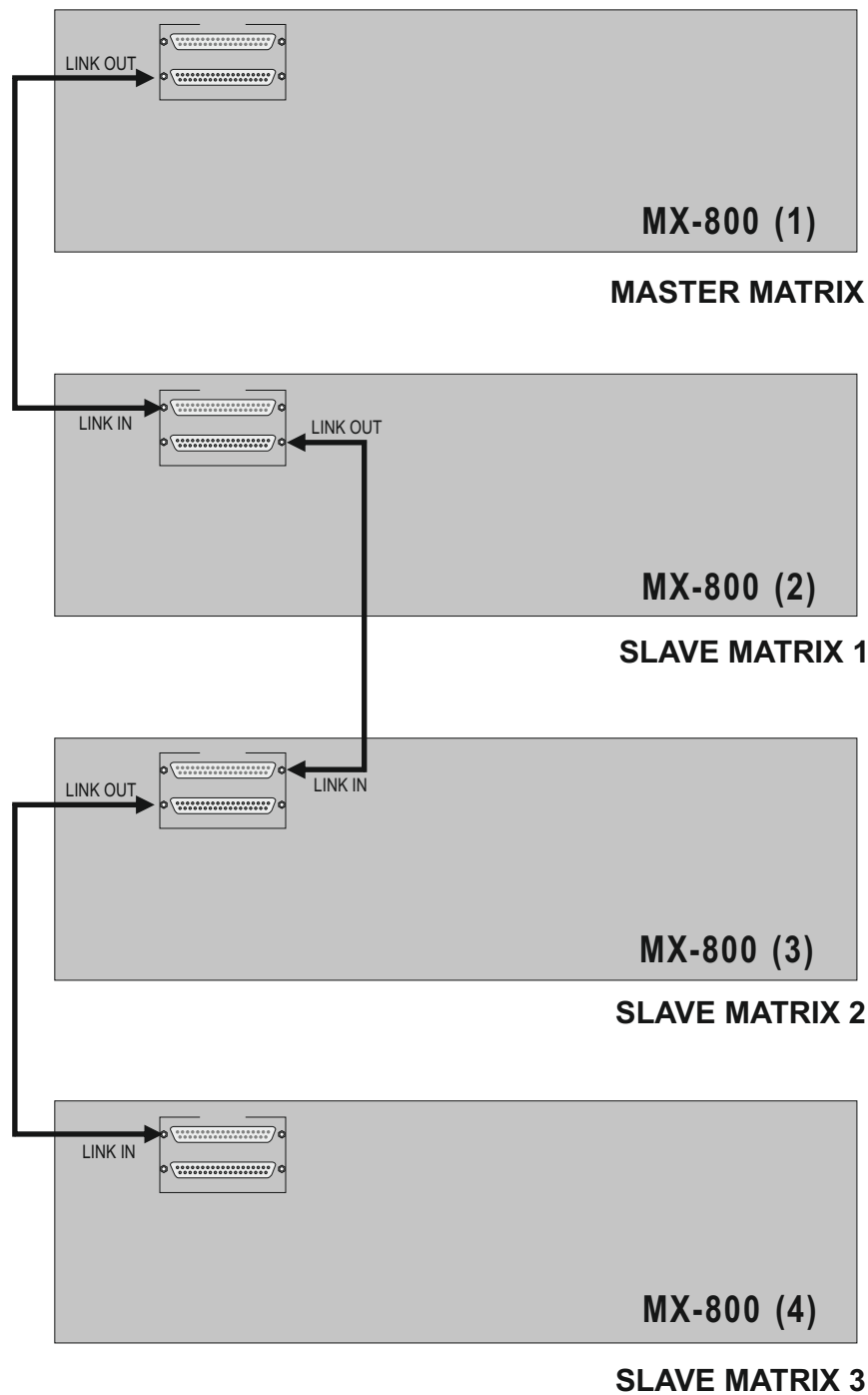

The different interconnected matrix must be correctly identified by using the switch (DIP ON). Any of the 4 combinations must be selected to identify if it as a MASTER matrix or any of the 3 SLAVE matrix available.

## SYSTEM CONFIGURATION

### 5. GENERAL CONFIGURATION

To complete the zone configuration two parameters must be configured:

**A•** Choose the input audio source for every audio output. Use the SOURCE UP and SOURCE DOWN and then press the "ENTER" button.

**B•** Choose whether you prefer the MIC1 to mute the rest of the audio sources (highest priority) or to be mixed with them (no priority). In order to enable the priority you must activated the "PRIORITY" switch and LED MIC1 will switch on.

The matrix includes an internal speaker to help you out while selecting the assignment of the inputs to each output. To do so you may use the MONITOR panel. You can listen to all inputs by pressing the ZONE SELECT button and then ENTER. You can also adjust the speaker's gain by using the knob.

**Caution!** In case any of the zones has a remote control panel enabled, the zone configuration will be disabled from the matrix. It must be done from the remote control panel itself.

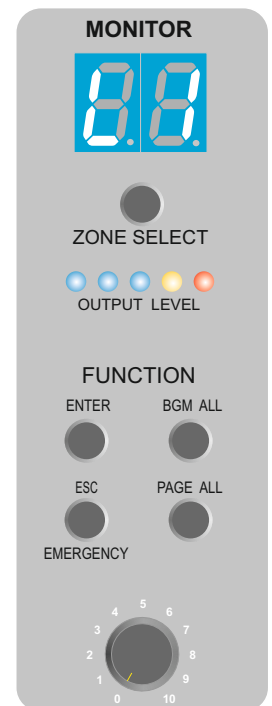
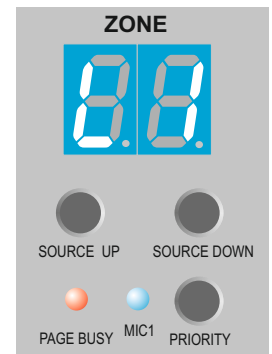

### 6. AUDIO EQUALIZATION

The MX-800 matrix provides several gain adjustments for audio inputs and outputs. Therefore, the following steps must be verified:

1. Adjust the gain control of every line input.
2. Adjust the gain control of all paging desks MX-801 from their rear panel as well as from the matrix's rear panel.
3. Adjust gain and equalization ( bass and treble) of the different audio outputs (zones).
4. Adjust all gain controls from the front panel ( MIC1, MUSIC and MASTER).
5. In case there are remote control panels connected to the matrix, the gain control of the local sources as well as the master gain control must be adjust form the same remote control panel by using the provided knobs: Master level ("Source level"), local sources ("Music level") and local microphone ("MIC").