

Independent room substation

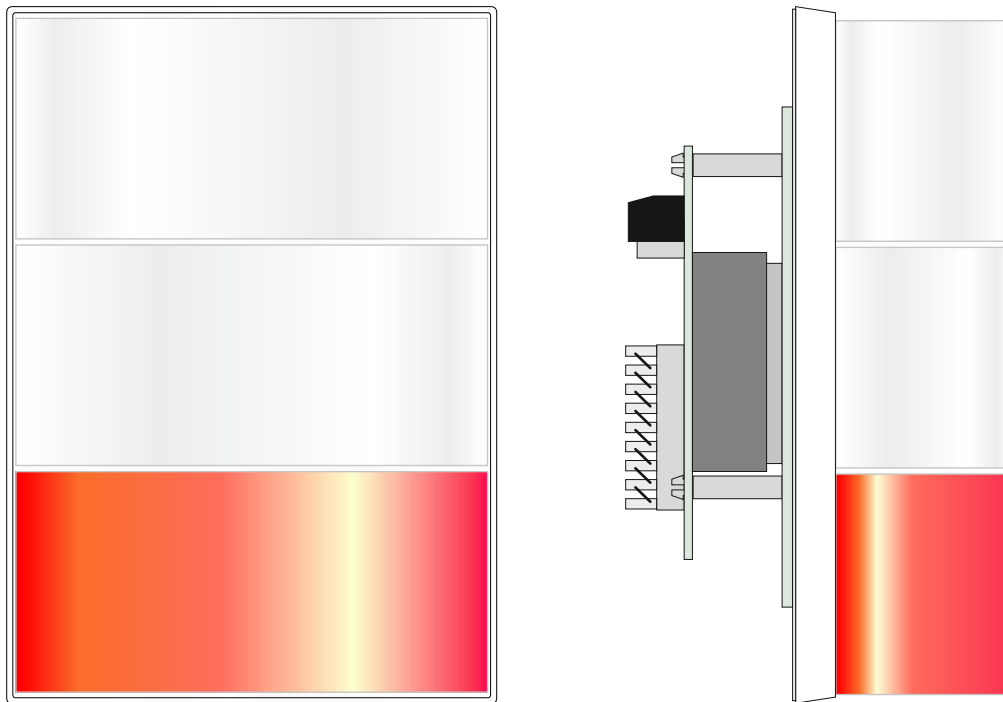

DESCRIPTION

Signaling device for calls proceeding from an independent bathroom.

It is specially designed to be used in independent bathrooms that are also compatible to be installed in the same system with UC-104 room substations and UC-102 central stations. The UDECOM system can support until 20 of these devices.

Its electronic microprocessor is integrated with the corridor lamp, all in one device only.

THE UC-140 independent bathroom substation has a red light illuminated by a bright led with energy-saving technology and higher lifespan.

Accessories:

The UC-140 independent bathroom substation requires a UW-14 bathroom call module and a UW-19.

The connection board allows the installation of the BUS data, power supply and bathroom call module and cancellation.

The wire connection and the wiring verification will be made independently from the rest of the installation, by using the UW-G Test emitter and the UW-R Test receiver.

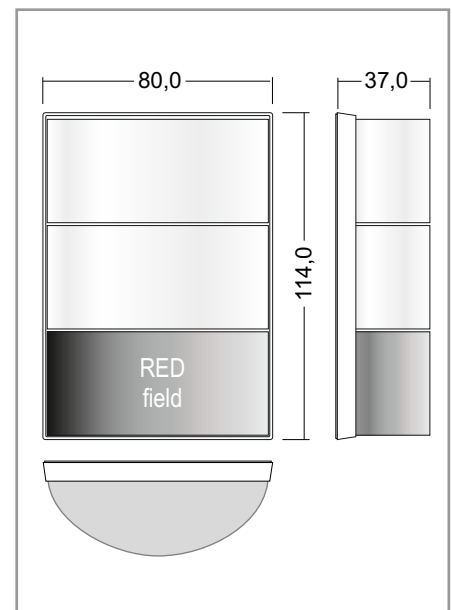

MOUNTING ACCESSORIES

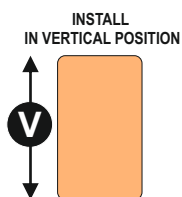

UW-84
SURFACE
BACK BOX

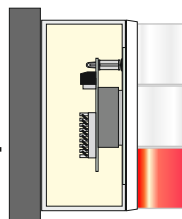

UW-94
FLUSH MOUNTED
BACK BOX FOR
SOLID WALL

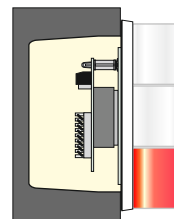

UW-74
FLUSH MOUNTED
BACK BOX FOR
CAVITY WALL

INSTALLATION PROCESS

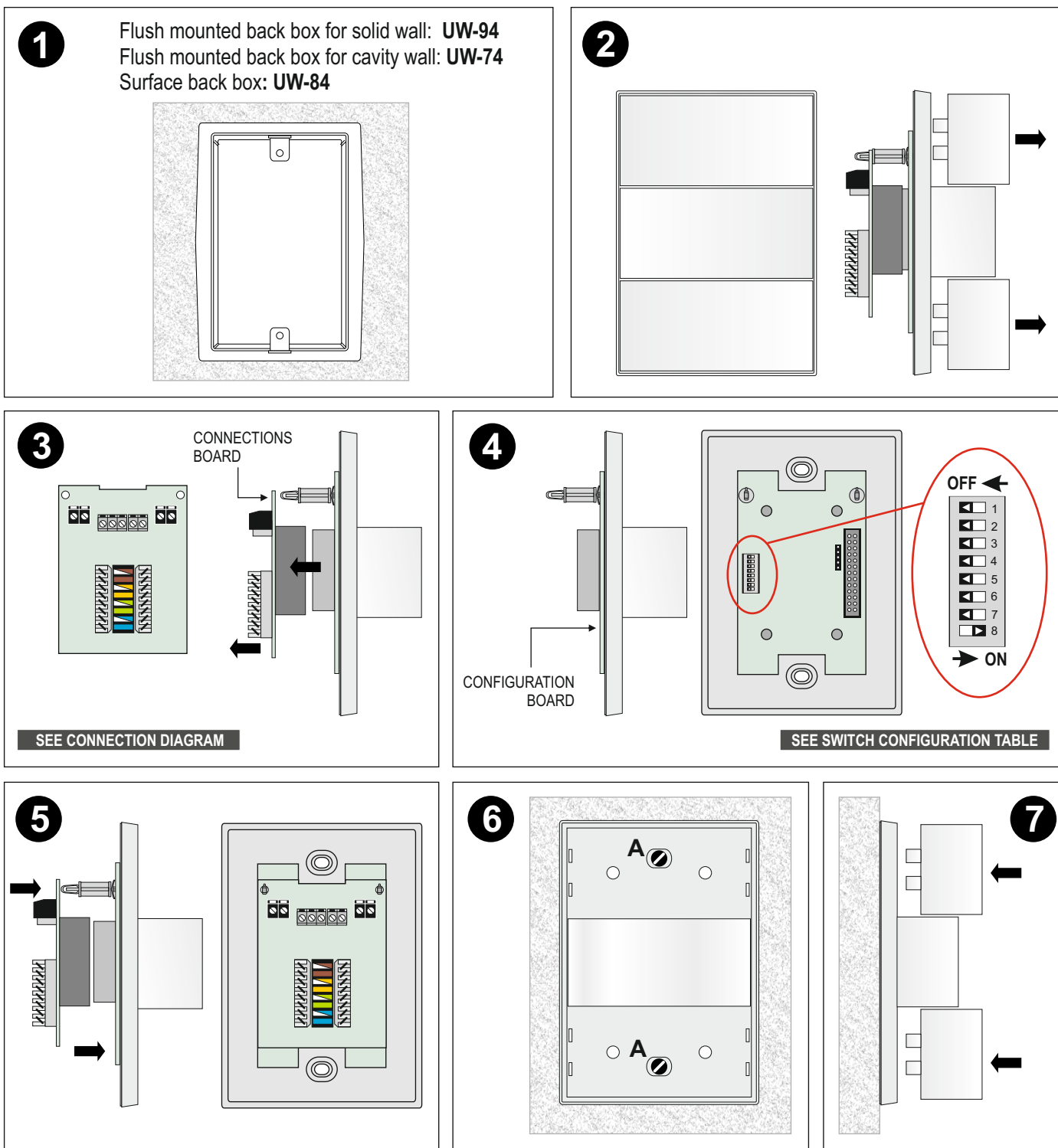

See configuration table

1. Install in vertical position.
2. Carefully remove the upper and lower diffusers of rear light. Leave the central diffuser in its position.
3. Remove the CONNECTION BOARD from the CONFIGURATION BOARD and afterwards wire as it is shown on the wiring diagram.
4. Configure the id system number of UC-140 Independent bathroom substation, by setting the micro switch DIP1 of CONFIGURATION BOARD.
5. Plug the CONNECTION BOARD to the CONFIGURATION BOARD.
6. Mount the UC-140 module in the back box, with the red light at the bottom. Fix the UC-140 module using the supplied screws (A).
7. Place the two diffusers.

WIRING DIAGRAM

Remove the CONNECTION BOARD and connect the associated modules to this substation (UW-14, UW-19)

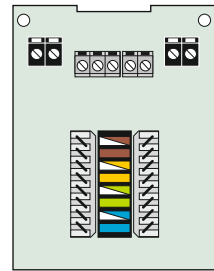
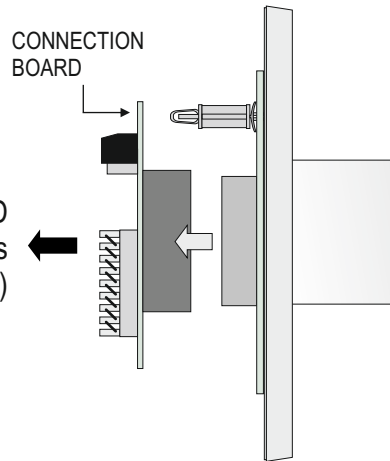

CONNECTION BOARD

**UW-14
BATHROOM
CALL MODULE**

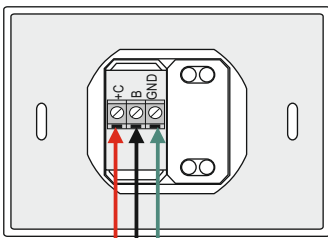

**UW-19
BATHROOM
CALL CANCELLATION**

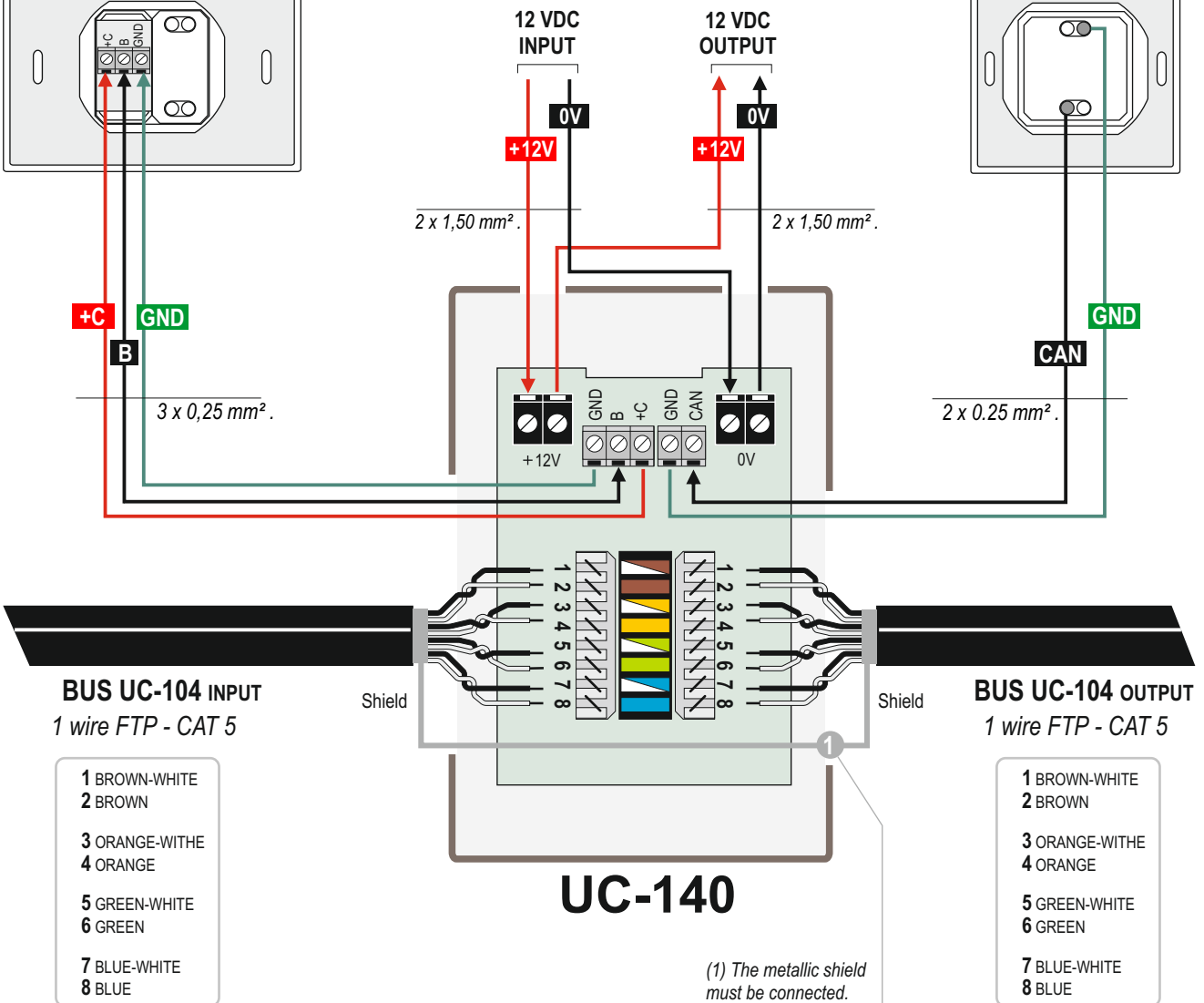
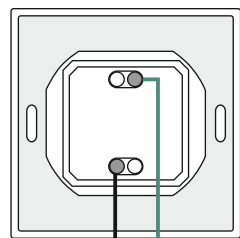

- 1 BROWN-WHITE
- 2 BROWN
- 3 ORANGE-WITHE
- 4 ORANGE
- 5 GREEN-WHITE
- 6 GREEN
- 7 BLUE-WHITE
- 8 BLUE

- 1 BROWN-WHITE
- 2 BROWN
- 3 ORANGE-WITHE
- 4 ORANGE
- 5 GREEN-WHITE
- 6 GREEN
- 7 BLUE-WHITE
- 8 BLUE

SWITCH CONFIGURATION PROCEDURE

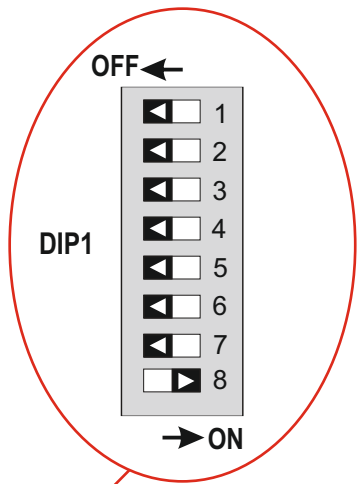
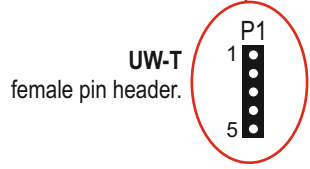
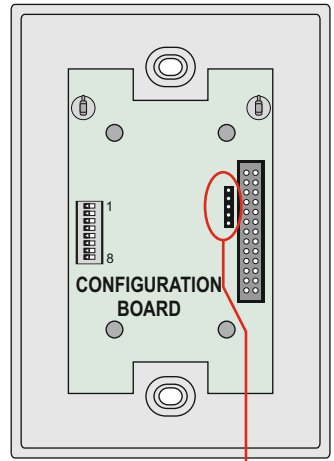
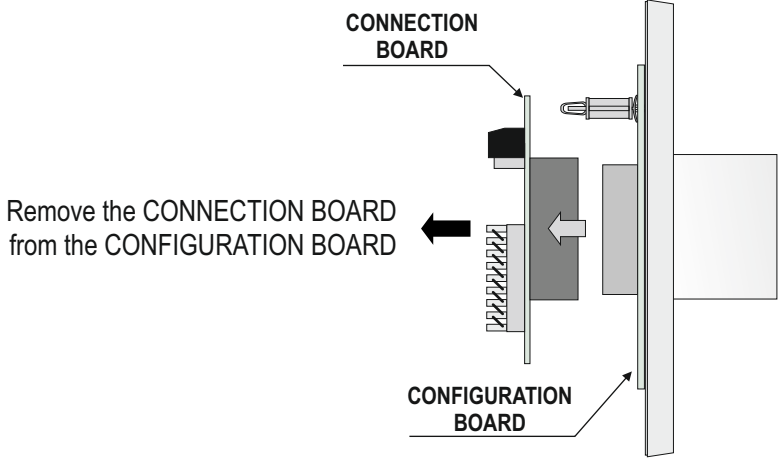

The UC-140 can be configured from ID number **65083 to 65102** (ID reserved) that will be recognized in the system as INDEPENDENT BATHROOM SUBSTATION from 1 to 20.

Switch the independent bathroom substation identifier using the micro switch **DIP1**.

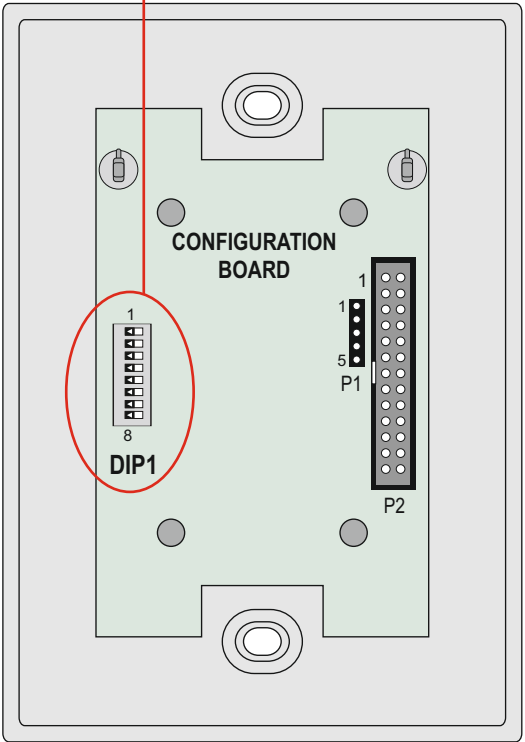

BATH N.	SWITCH POSITIONS								
	8	7	6	5	4	3	2	1	
65083	1	ON	ON	OFF	ON	OFF	OFF	ON	OFF
65084	2	ON	ON	OFF	ON	OFF	OFF	ON	ON
65085	3	ON	ON	OFF	ON	OFF	ON	OFF	OFF
65086	4	ON	ON	OFF	ON	OFF	ON	OFF	ON
65087	5	ON	ON	OFF	ON	OFF	ON	ON	OFF
65088	6	ON	ON	OFF	ON	OFF	ON	ON	ON
65089	7	ON	ON	OFF	ON	ON	OFF	OFF	OFF
65090	8	ON	ON	OFF	ON	ON	OFF	OFF	ON
65091	9	ON	ON	OFF	ON	ON	OFF	ON	OFF
65092	10	ON	ON	OFF	ON	ON	OFF	ON	ON
65093	11	ON	ON	OFF	ON	ON	ON	OFF	OFF
65094	12	ON	ON	OFF	ON	ON	ON	OFF	ON
65095	13	ON	ON	OFF	ON	ON	ON	ON	OFF
65096	14	ON	ON	OFF	ON	ON	ON	ON	ON
65097	15	ON	ON	ON	OFF	OFF	OFF	OFF	OFF
65098	16	ON	ON	ON	OFF	OFF	OFF	OFF	ON
65099	17	ON	ON	ON	OFF	OFF	OFF	ON	OFF
65100	18	ON	ON	ON	OFF	OFF	OFF	ON	ON
65101	19	ON	ON	ON	OFF	OFF	ON	OFF	OFF
65102	20	ON	ON	ON	OFF	OFF	ON	OFF	ON